



ARPANEL

PRODUCT DATA SHEET
ARPANEL XS PIR

DUAL SKIN



DUAL SKIN

PRODUCT DATA SHEET ARPANEL XS PIR

ARPANEL

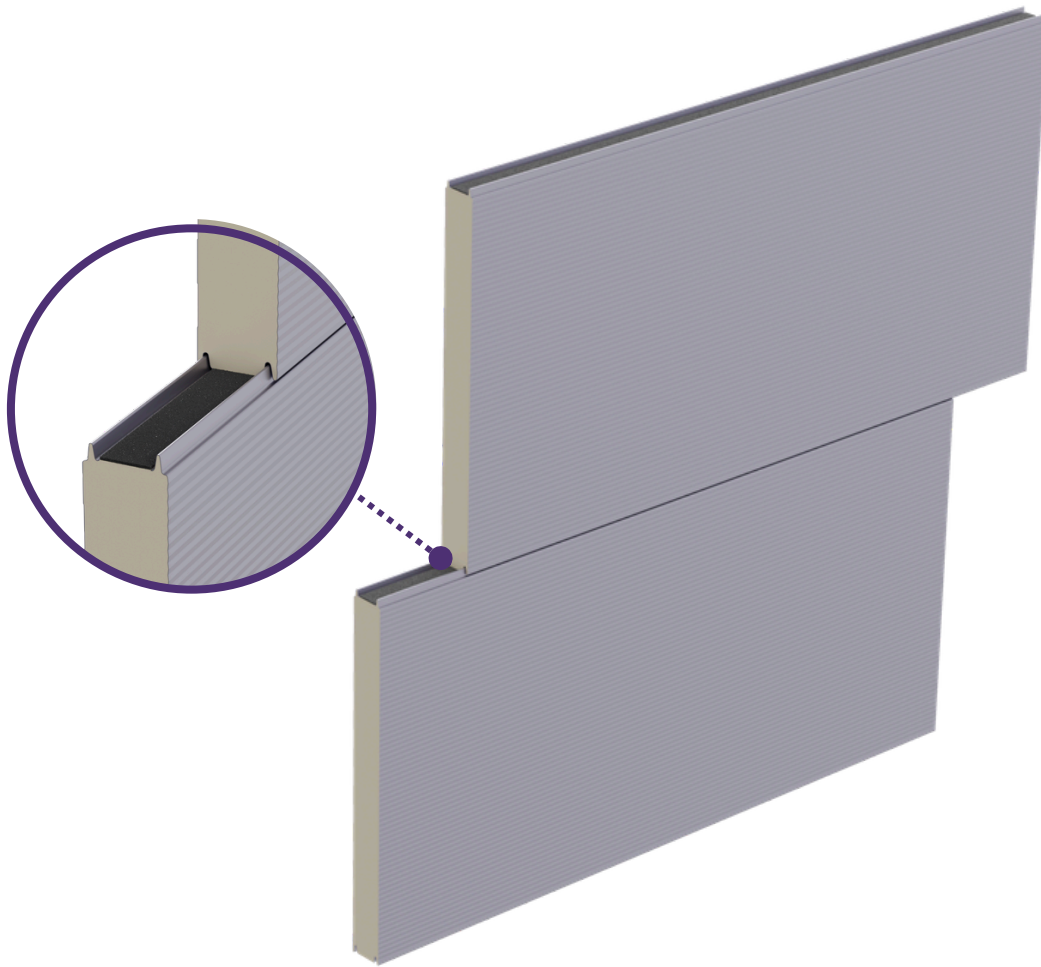

CROSS SECTION

Width: 1 000, 1 100, 1 150 mm



D = 80, 100 mm

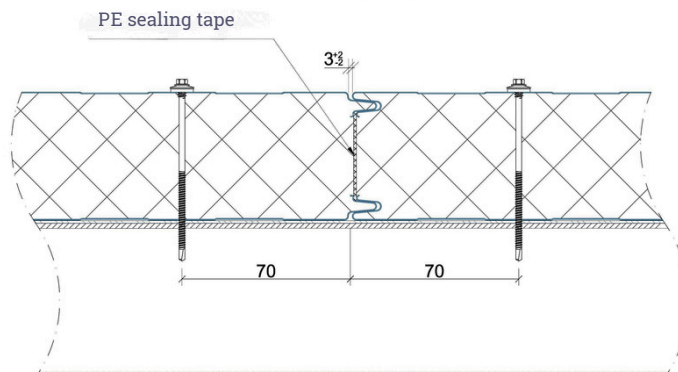

**DUAL SKIN**

PRODUCT DATA SHEET
ARPANEL XS PIR

ARPANEL**PARAMETERS**



Core thickness	80	100
External facing thickness [mm]	0,6 – 0,7	
Internal facing thickness [mm]	0,4 – 0,7	
Core density	42 ± 2 kg/m ³	
Weight [kg/ m ²]	12,5	13,4
Proper acoustic insulation [Rw(C,Ctr) dB]	25 (-2;-4)	
Sound absorption [αw]	0,15	
Heat transfer coefficient Ud,S = W/(m ² x K)	0,27	0,22
Reaction to fire	B-s1,d0	
Fire spread according to PN-B-02867	NRO	
Fire resistance according to EN 13501-2 vertical	E 15(i↔i) / EI 15(i↔o) ≤ 4 m ⁽¹⁾	E 20(i→o) / EI 20(i→o) / EW 20(i→o) ≤ 7,5 m ⁽²⁾ E 30(i→o) / EI 30(i→o) / EW 30(i→o) ≤ 3 m ⁽²⁾
Fire resistance according to EN 13501-2 horizontal	E 20(o↔i) / EI 20(o↔i) / EW 20(o↔i) ≤ 4 m ⁽¹⁾	E 20(o↔i) / EI 20(o↔i) / EW 20(o↔i) ≤ 7,5 m ⁽¹⁾ E 30(o↔i) / EI 30(o↔i) / EW 30(o↔i) ≤ 4 m ⁽¹⁾

¹ The declared fire resistance performance can only be achieved when a sealing compound is used.

² The declared fire resistance performance can only be achieved when an EPDM gasket is installed in the joint on the external side.

Installation details are available in the fire classifications of ARPANEL sandwich panels.

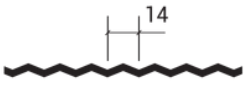
PROFILES

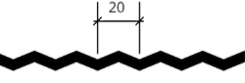
Name	external	internal	cross-section
Mikro 14	✓	✗	
Linear	✗	✓	
Smooth	✗	✓	
Mikro 20	✗	✓	

TYPES OF STANDARD COATINGS

Polyester – PE

*Other types of coatings, e.g. PVDF, PUR PA, HDX, PRISMA, FOODSAFE, HPS, SDP, are available upon request.

ENVIRONMENT IN CASE OF A STANDARD COATING, POLYESTER – PE

A possibility to apply inside, in environments A1, A2, A3 and outside buildings C1, C2, C3.

*For environments characterized by higher aggressiveness, a coating that meets the requirements of a given corrosivity category should be selected.



DUAL SKIN

PRODUCT DATA SHEET ARPANEL XS PIR

ARPANEL

STANDARD COLORS

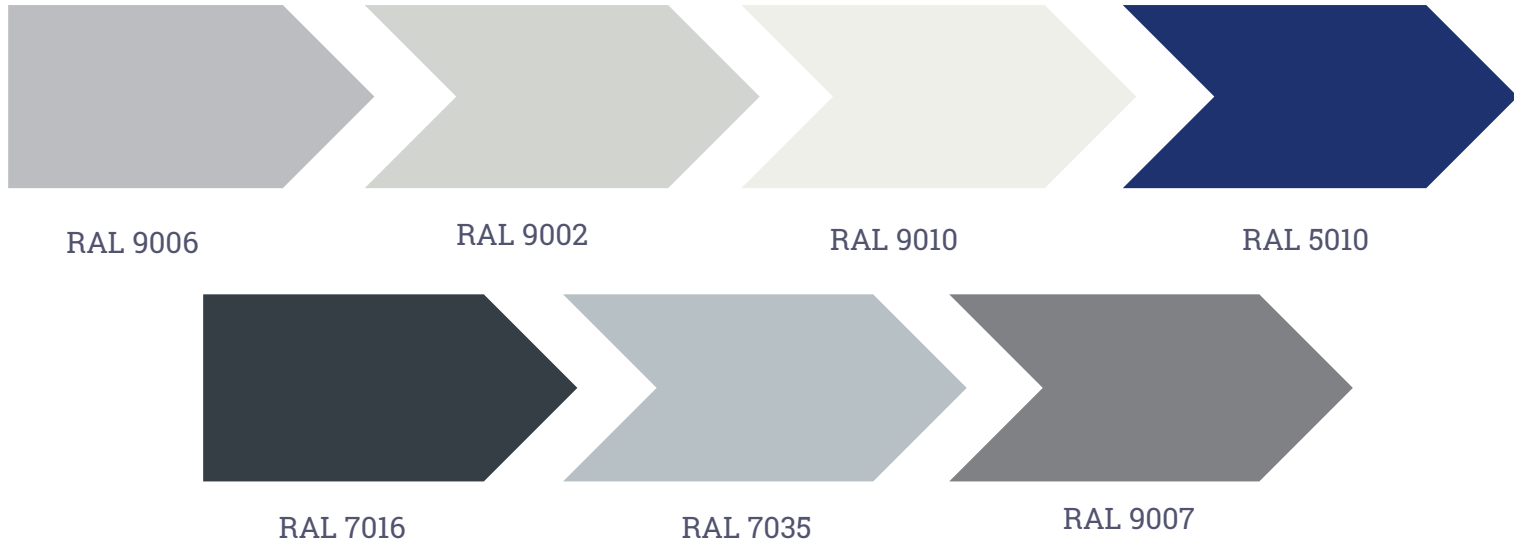

RAL 9006

RAL 9002

RAL 9010

RAL 5010

RAL 7016

RAL 7035

RAL 9007

Ask our representative about the availability of other standard colors of ARPANEL sandwich panels.

AVAILABLE LENGTHS OF PANELS

Standard lengths of panels are from 2,0 m to 18,5 m.

PERMISSIBLE DEVIATIONS FROM DIMENSIONS

According to EN 14509:

Panels with length of ≤ 3 m ± 5 mm

Panels with length of > 3 m ± 10 mm

For the covering width of the sandwich panel, ± 2 mm

At the panel thickness:

For $D \leq 100$ mm ± 2 mm

For $D > 100$ mm ± 2 %

Rectangularity of cut at the length $\leq 0,6$ % of the panel width

Panel:

2 mm per each meter of length, but not more than 20 mm

8,5 mm per each meter of width, but not more than 10 mm

The presented contents and drawings are demonstrative material only. Adamietz S.A., the producer of sandwich panels ARPANEL, is not responsible for any differences between the content of the product card and the real products parameters. The producer reserves the right to implement changes and modifications to the content without prior notice. Pursuant to the Civil Code, the content of the product card does not constitute a commercial offer.

Adamietz S.A., the producer of sandwich panels ARPANEL, is the copyright holder of the materials included in this product card. The content of the materials is protected by the copyright. The sale, publication, licensing or any distribution of the part or the whole of these works is prohibited without the written consent of Adamietz S.A.

The design of these materials and the information concerning the offered products are the property of the Adamietz company. Copying and the reproduction of the materials by third parties in conducting business activity without information on their origin will constitute an act of unfair competition.